

EX-66

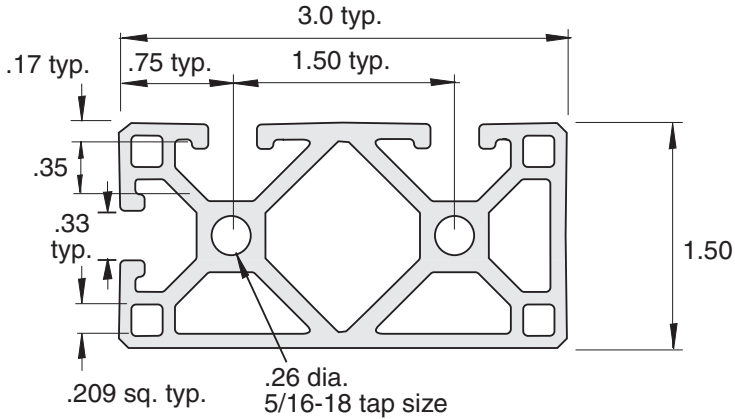

- Finish = Clear anodized
- Material = 6105-T5 Aluminum
- Est. Area = 1.559 Sq. In.
- Weight/ft = 1.833 lbs.
- 96", 192.63" Lengths standard.

Section Properties:

Moment of Inertia in ⁴	1.385	0.401
Section modulus in ³	0.923	0.535



Load condition:
Fixed at both ends, load at center
Deflection = y (inches)

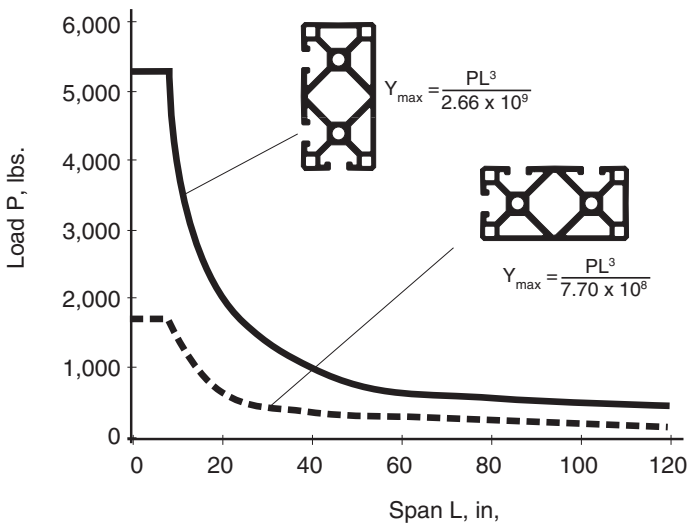
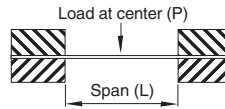

TECHNICAL

Load condition:
Fixed at one end, sliding at one end,
load at center
Deflection = Y (inches)

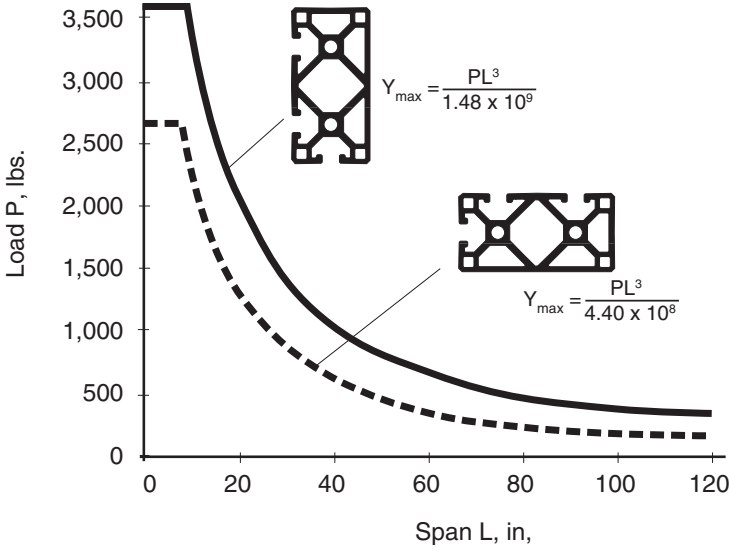
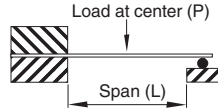

Load condition:
Fixed at one end,
load at unsupported end
Deflection = Y (inches)

