

Joining Plate

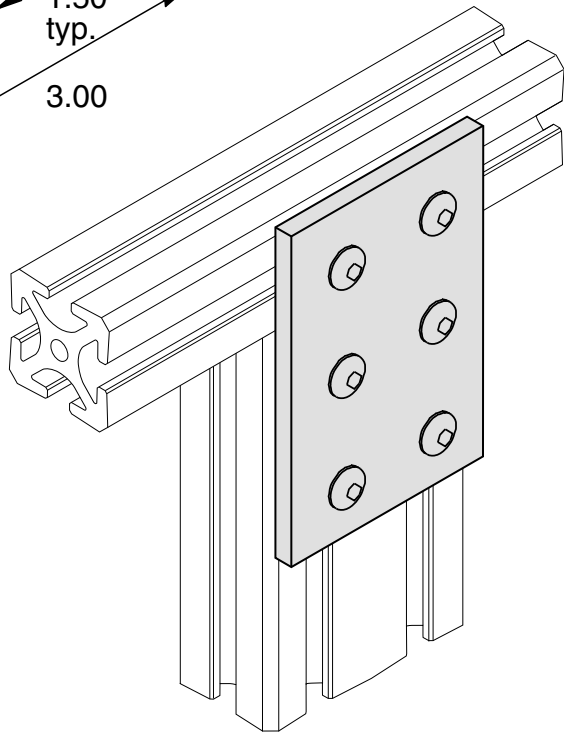

EB-32

5/16" SLOTS

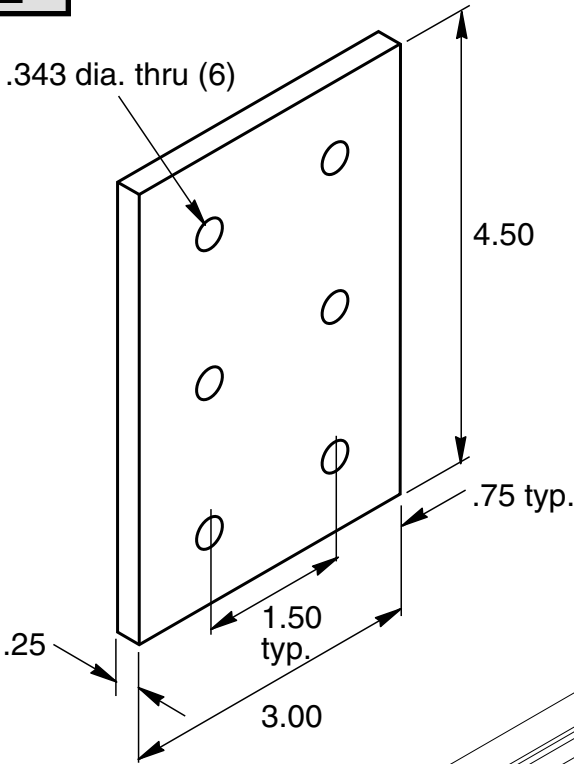

Recommended Hardware
(6) EF-12-.63 BHCS
(6) EF-2 T-nut

Material - Aluminum
Finish - Clear Anodize