

11-73

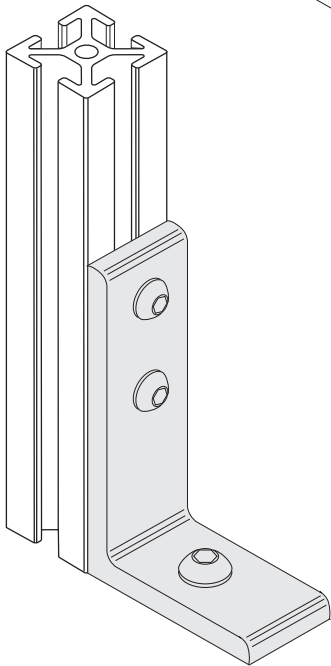
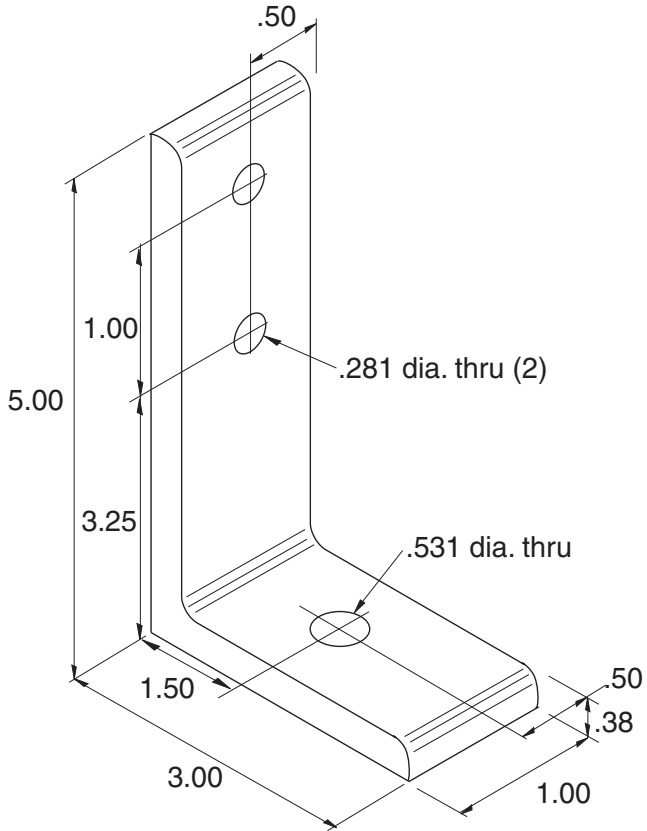

1/4" SLOTS

Recommended Hardware
(2) 11-232 BHCS
(2) 11-205 T-nut

Material - Aluminum
Finish - Clear Anodize